



150mm x 150mm

200mm x 150mm

250mm x 150mm

300mm x 150mm

Extrusion 150mm



End Cap 150mm

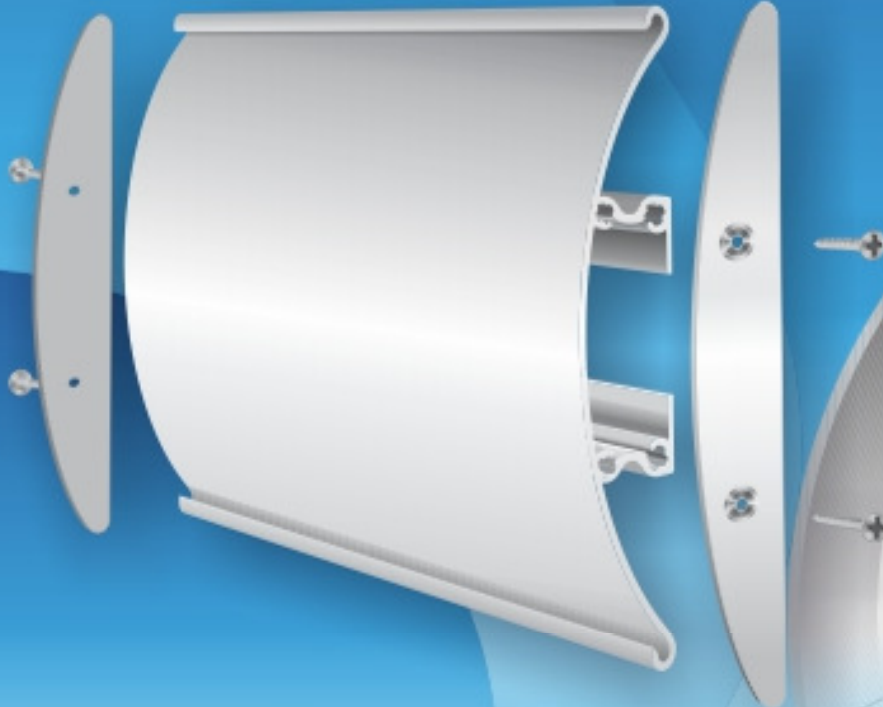

Name:	Single Sided Panel
Size:	300mm x 150mm
Material:	Aluminium 6063/T6 - Natural Anodised
Inserts:	Vinyl applied to 0,9mm ABS (Optional)
Colour:	Client request
Fitting:	Wall Mounted
Font/Graphic:	Client request
Sizes:	Client request

Pylon Base 1200mm (Steel)

Extrusions

1030mm x 2000mm

End Cap 1030mm

Name: Double Sided Free standing Pylon illuminated

Size: 1030mm x 2000mm

Material: Aluminium 6063/T6 - Natural Anodised

Inserts: Vinyl applied to 0,9mm ABS (Optional)

Colour: Client request

Fitting: Free Standing

Font/Graphic: Client request

Sizes: Client request



Before Fold 305mm

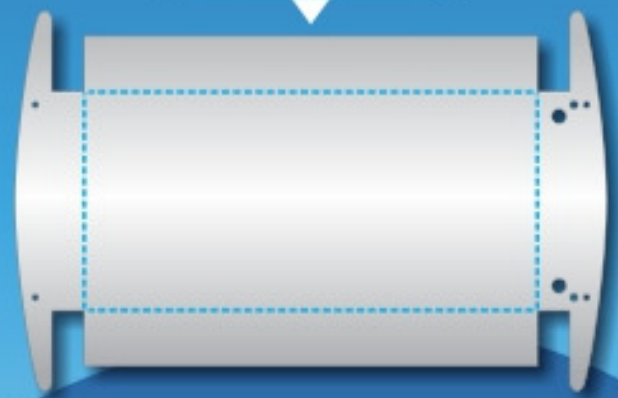

Folded Sides 213mm



Name:	Teller Numbers
Size:	215 x 215mm
Material:	Aluminium 6063/T6 - Natural Anodised
Inserts:	Vinyl applied to 1.5mm UHI (Optional)
Colour:	Client request
Fitting:	Bulkhead Suspended
Font/Graphic:	Client request
Sizes:	Client request



200mm x 75mm



300mm x 75mm

Extrusion 75mm



200mm x 150mm



300mm x 150mm

Extrusion 150mm



End Cap

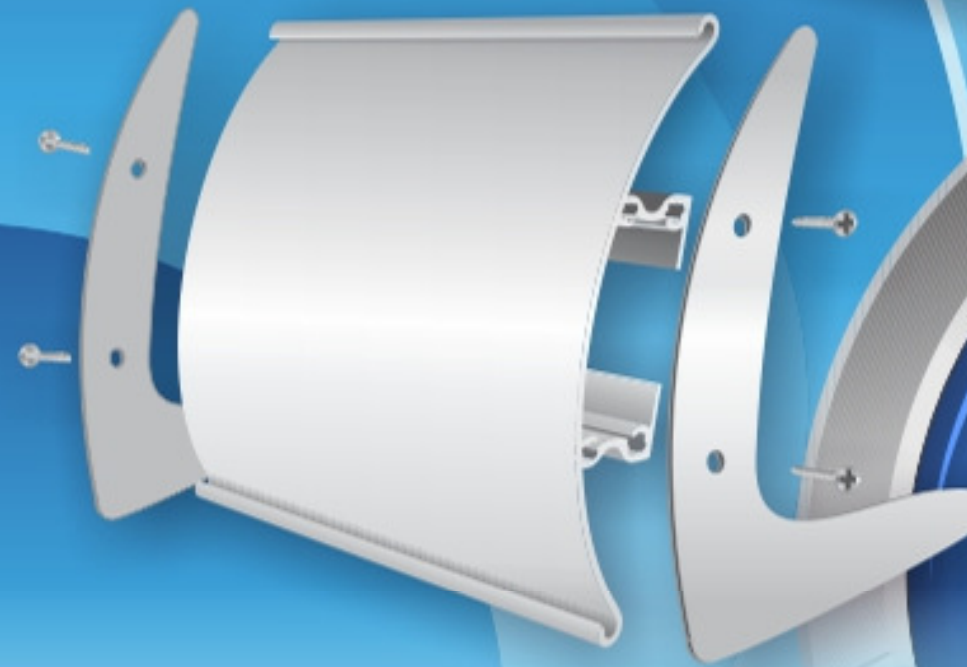

Name:	Deskstand
Size:	Client Request
Material:	Aluminium 6063/T6 - Natural Anodised
Inserts:	Vinyl applied to 0,9mm ABS (Optional)
Colour:	Client request
Fitting:	Free Standing
Font/Graphic:	Client request
Sizes:	Client request

680mm x 1200mm

680mm x 1630mm

680mm x 1800mm

680mm x 2000mm

End Cap 680mm

Extrusions

Steel Baseplate

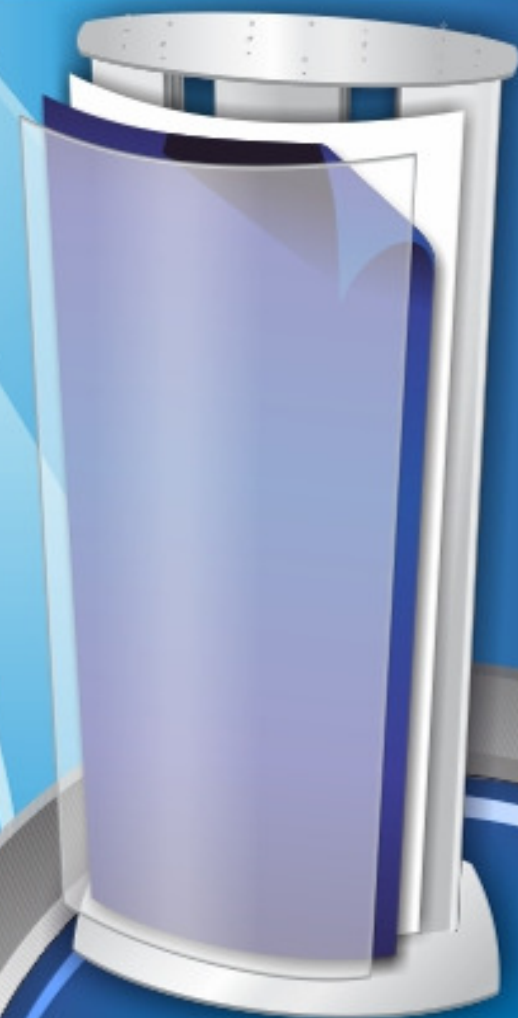

Name:	Double Sided Free Standing Unit
Size:	680 x 1630mm
Material:	Aluminium 6063/T6 - Natural Anodised
Inserts:	Vinyl applied to 0,9mm ABS & 1,5mm UHI NR (Optional)
Colour:	Client request
Fitting:	Free Standing
Font/Graphic:	Client request
Sizes:	Client request

680mm x 800mm

680mm x 1000mm

680mm x 1200mm

680mm x 1800mm

End Cap 680mm

Extrusions

Steel Baseplate

Name:	Double Sided Free Standing Poster Frame
Size:	680 x 1000mm
Material:	Aluminium 6063/T6 - Natural Anodised
Inserts:	Vinyl applied to 0,9mm ABS & 1,5mm UHI NR (Optional)
Colour:	Client request
Fitting:	Free Standing
Font/Graphic:	Client request
Sizes:	Client request

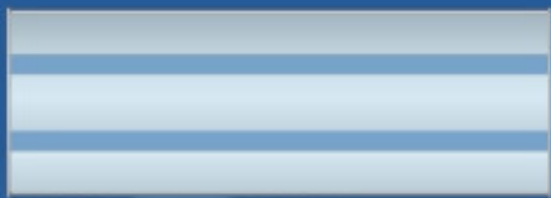

3000mm x 680mm



4000mm x 680mm

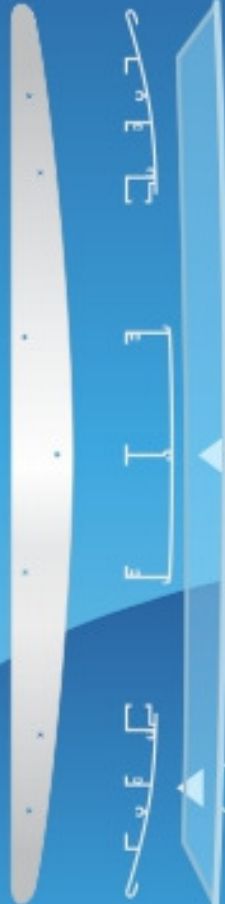

End Cap 680mm



Name:	Multi Poster Set
Size:	680mm x 3000mm
Material:	Aluminium 6063/T6 - Natural Anodised
Inserts:	Vinyl applied to 0,9mm ABS & 1,5mm UHI NR (Optional)
Colour:	Client request
Fitting:	Wall Mounted
Font/Graphic:	Client request
Sizes:	Client request

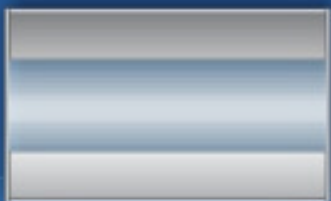

1500 x 680mm

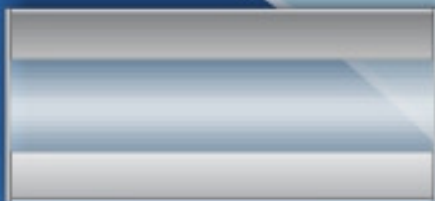

2000 x 680mm



End Cap 680mm

ABS

Extrusion 150mm



Name:	Multi Poster Set
Size:	680mm x 2000mm
Material:	Aluminium 6063/T6 - Natural Anodised
Inserts:	Vinyl applied to 0,9mm ABS & 1,5mm UHI NR (Optional)
Colour:	Client request
Fitting:	Wall Mounted
Font/Graphic:	Client request
Sizes:	Client request



680mm x 1000mm



End Cap 680mm

ABS

Extrusion 150mm



Name:	Poster Frame
Size:	680mm x 1000mm
Material:	Aluminium 6063/T6 - Natural Anodised
Inserts:	Vinyl applied to 0,9mm ABS & 1,5mm UHI NR (Optional)
Colour:	Client request
Fitting:	Wall Mounted
Font/Graphic:	Client request
Sizes:	Client request



End Caps



Extrusion 150mm



Name: Double Sided Suspended
Size: 750mm x 150mm
Material: Aluminium 6063/T6 - Natural Anodised
Inserts: Vinyl applied to 0,9mm ABS (Optional)
Colour: Client request
Fitting: Suspended
Font/Graphic: Client request
Sizes: Client request



300mm x 600mm

300mm x 800mm

300mm x 1200mm

300mm x 1600mm

Extrusions 150mm



End Cap

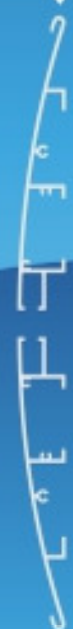

Brochure Holder

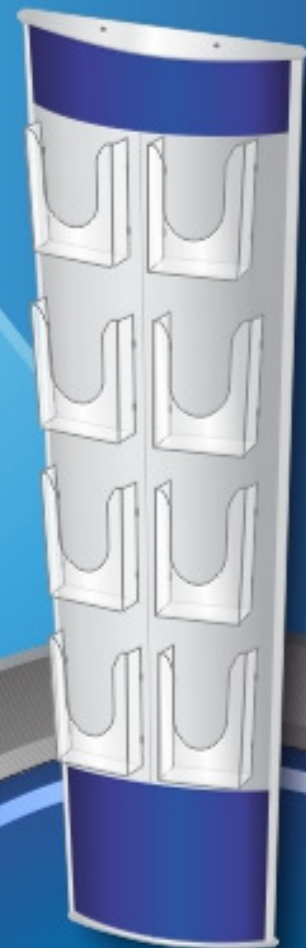
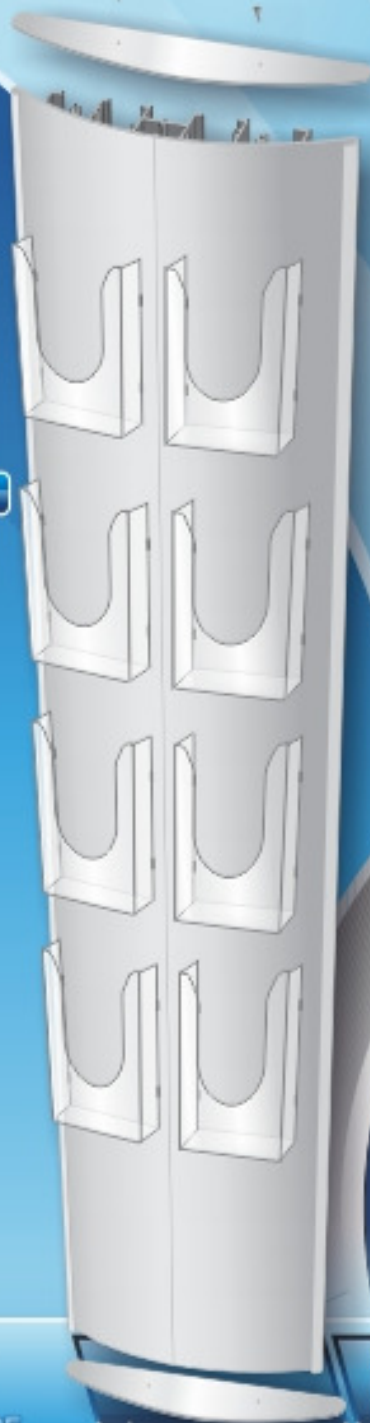

Name: Wall Mounted Brochure Unit
Size: 300mm x 1600mm
Material: Aluminium 6063/T6 - Natural Anodised
Inserts: Vinyl applied to 0,9mm ABS (Optional)
Colour: Client request
Fitting: Wall Mounted
Font/Graphic: Client request
Sizes: Client request

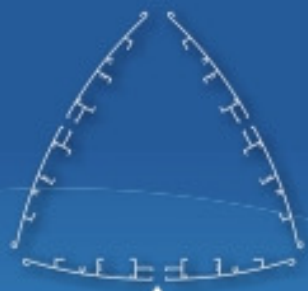

Extrusions 300 x 300 x 300mm



300mm x 1000mm



300mm x 1200mm



300mm x 1342mm



300mm x 1800mm



Trisland Top 300 x 300 x 300mm



Position Holder 60mm



Trisland Base 463mm x 479mm



Brochure Holder



Name:	Trisland Single Tier Brochure Unit
Size:	300mm x 1342mm
Material:	Aluminium 6063/T6 - Natural Anodised
Inserts:	Vinyl applied to 0,9mm ABS (Optional)
Colour:	Client request
Fitting:	Free Standing
Font/Graphic:	Client request
Sizes:	Client request



Extrusions 300 x 300 x 300mm



300mm x 1000mm

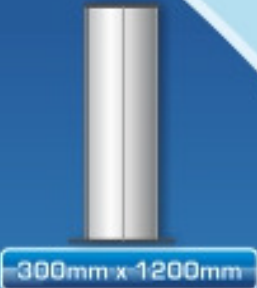

300mm x 1200mm



300mm x 1342mm



300mm x 1800mm



Tristand Top 300 x 300 x 300mm



Position Holder 60mm



Tristand Base 463mm x 479mm



Name:	Tristand
Size:	300 x 1342mm
Material:	Aluminium 6063/T6 - Natural Anodised
Inserts:	Vinyl applied to 0,9mm ABS (Optional)
Colour:	Client request
Fitting:	Free Standing
Font/Graphic:	Client request
Sizes:	Client request

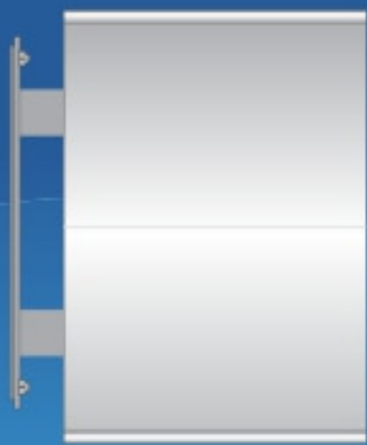

Silver



White

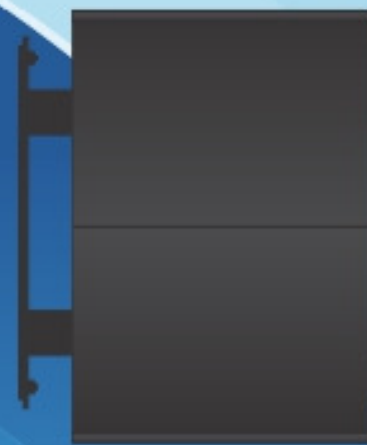

Black

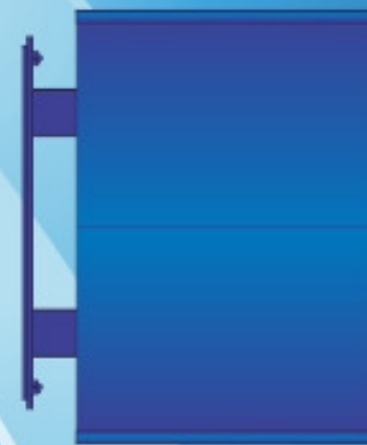

Blue

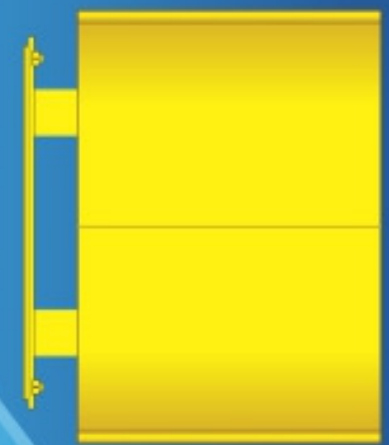

Yellow

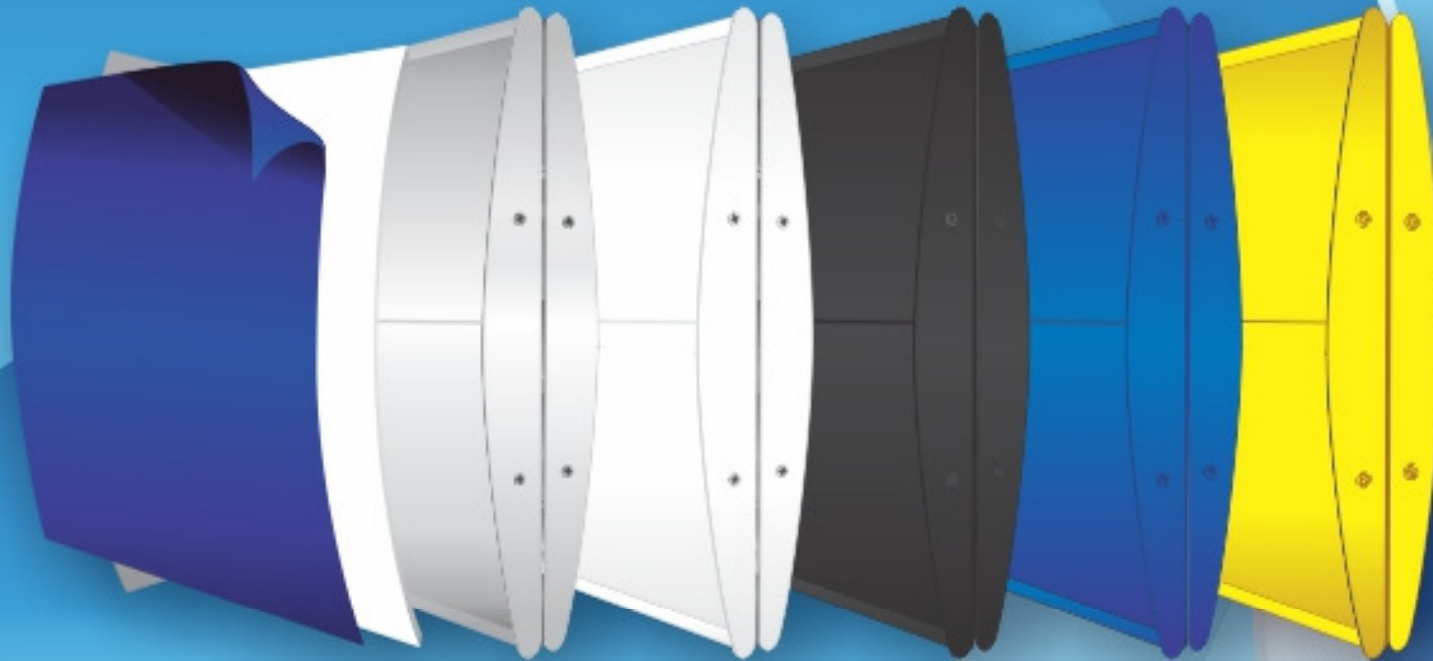

Products in Assorted Colours According to Client Request



Suction Cup 30mm

Extrusions 150mm

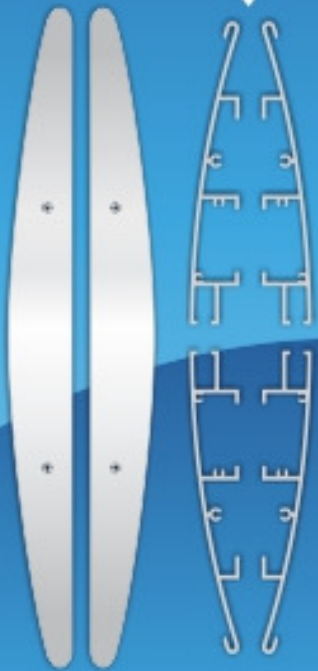

Flagged Sign End Cap 300mm



215mm x 300mm

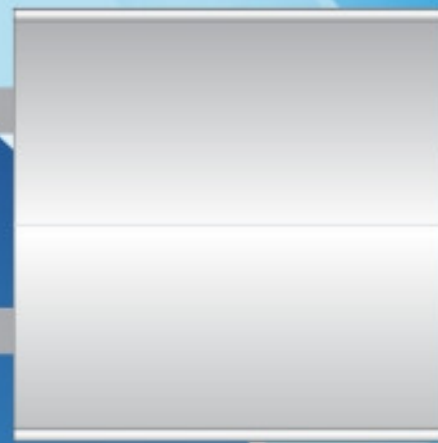

300mm x 300mm

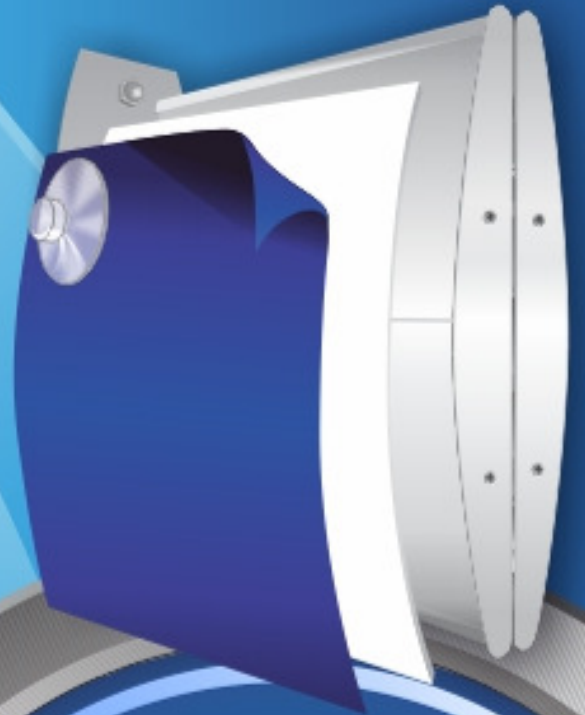
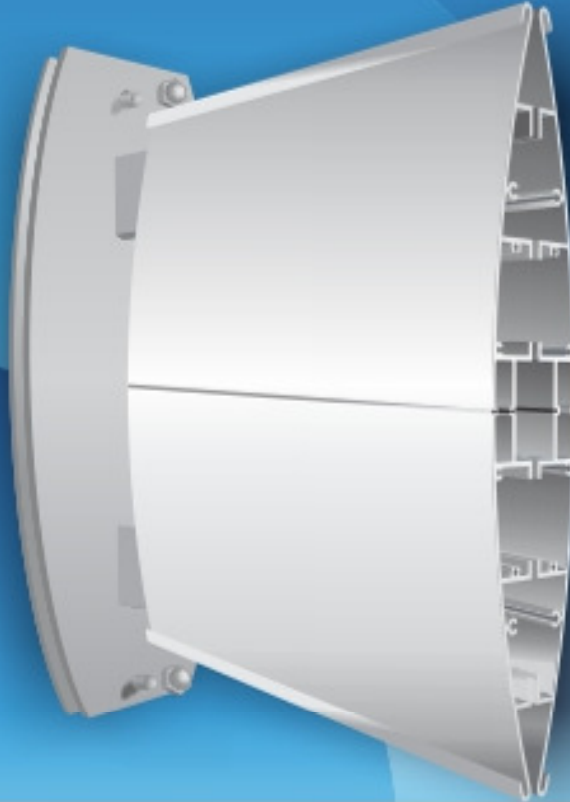

Name:	Double Sided Projection
Size:	215mm x 300mm
Material:	Aluminium 6063/T6 - Natural Anodised
Inserts:	Vinyl applied to 0,9mm ABS (Optional)
Colour:	Client request
Fitting:	Flagged
Font/Graphic:	Client request
Sizes:	Client request

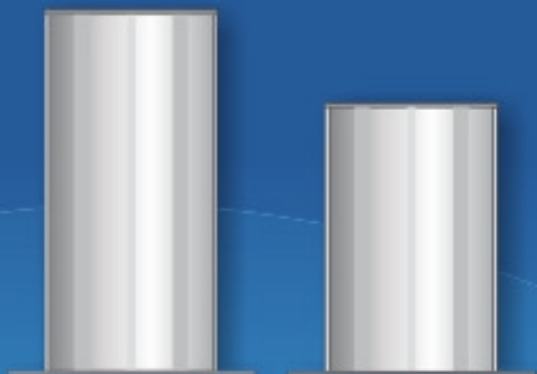

906mm x 2000mm

906mm x 1750mm

End Cap 121mm x 906mm

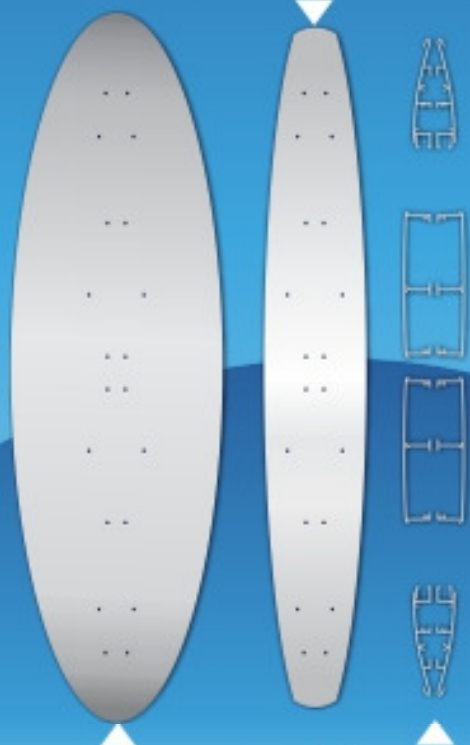

Free Standing Baseplate (Steel)

Extrusions



Name:	Double Sided Free Standing Unit
Size:	906mm x 2000mm with 1200mm baseplate
Material:	Aluminium 6063/T6 - Natural Anodised
Inserts:	Printed 0,9mm ABS & 1,5mm UHI NR (Optional)
Colour:	Client request
Fitting:	Free Standing
Font/Graphic:	Client request
Sizes:	Client request



Suction Cup 30mm



215mm x 300mm

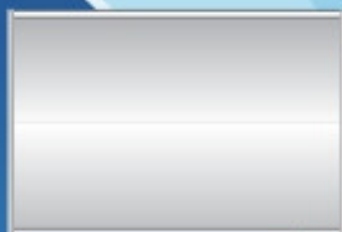

450mm x 300mm

Extrusions 150mm X2



End Cap 300mm

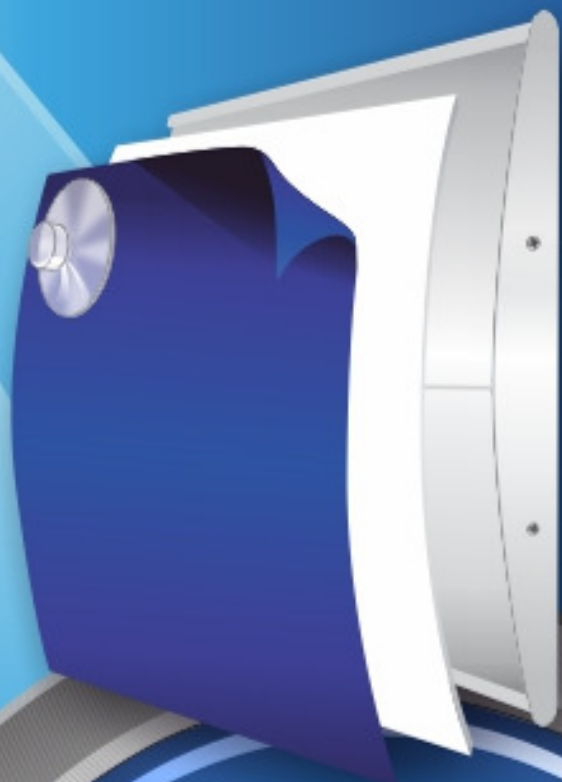
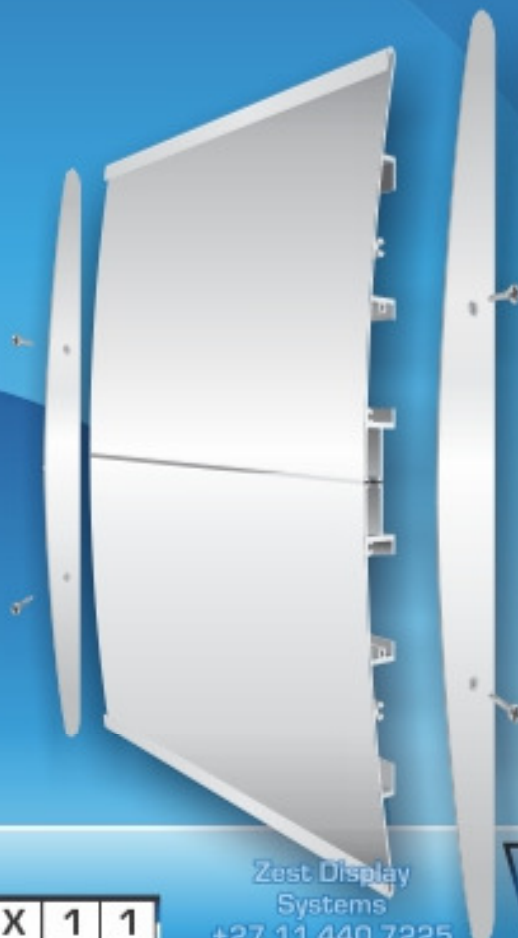

Name:	Single Sided Panel
Size:	215mm x 300mm
Material:	Aluminium 6063/T6 - Natural Anodised
Inserts:	Vinyl applied to 0,9mm ABS (Optional)
Colour:	Client request
Fitting:	Wall Mounted
Font/Graphic:	Client request
Sizes:	Client request